

THIS DRAWING IS AN OVERALL REPRESENTATION OF THE APPARATUS AS PROPOSED.

THE EXACT DIMENSIONS, LOCATIONS OF ACCESSORIES AND/OR COMPONENTS MAY BE REVISED PENDING COMPLETE ENGINEERING OF THE CUSTOM REQUIREMENTS OF THE INDIVIDUAL APPARATUS ORDER.

IF THERE IS A DISCREPANCY BETWEEN THE BODYBUILDER PRINT AND THE WRITTEN PROPOSAL, THE SPECIFICATIONS WITHIN THE PROPOSAL PREVAIL.

This drawing along with any changes made and initiated by both the "Fire Department" & HME, Inc. represents what will be constructed and supplied to the "Fire Department." Any changes to the contract specifications and drawing after today's date will be addressed via appropriate change order signed and approved by both the "Fire Department" & HME, Inc.

APPROVED BY: _____ TITLE: _____
 FIRE DEPARTMENT

APPROVED BY: _____ TITLE: _____
 HME, Incorporated

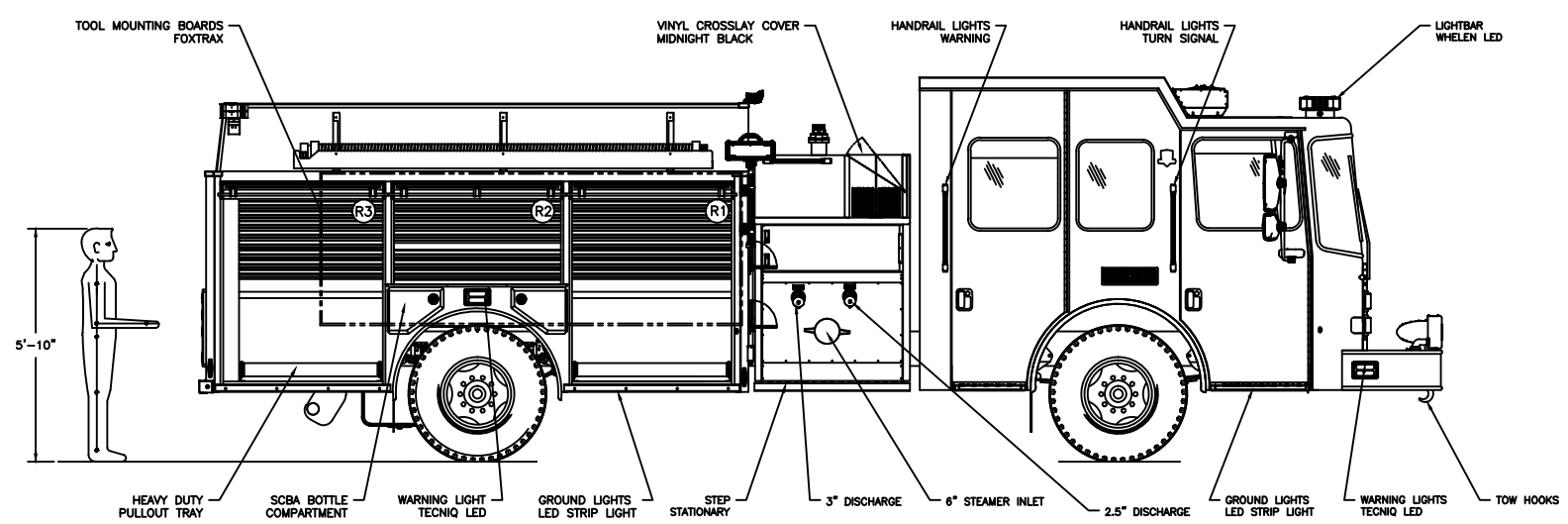
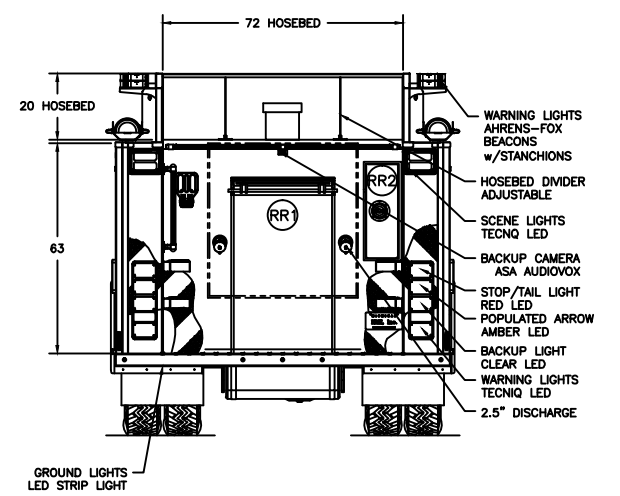
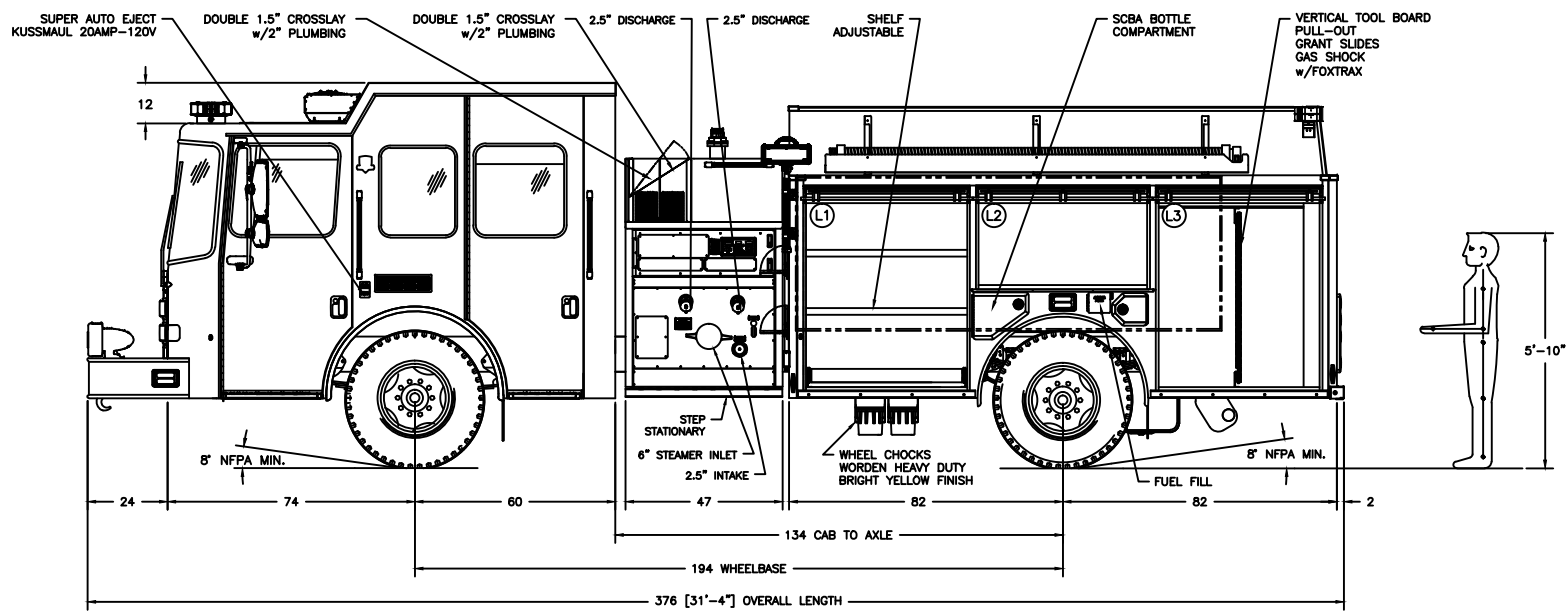
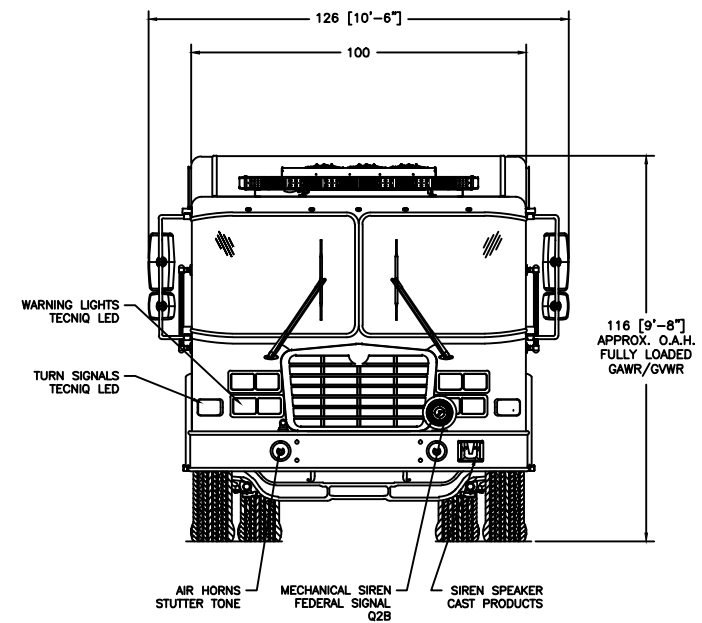
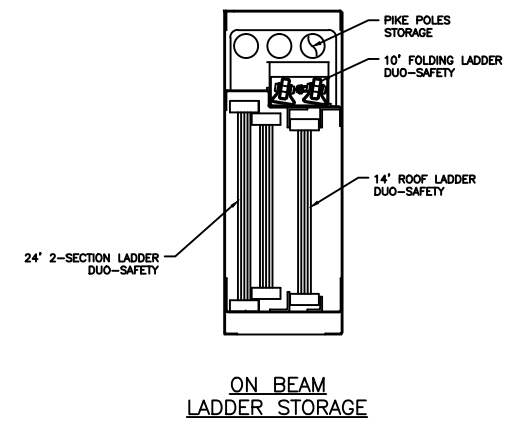
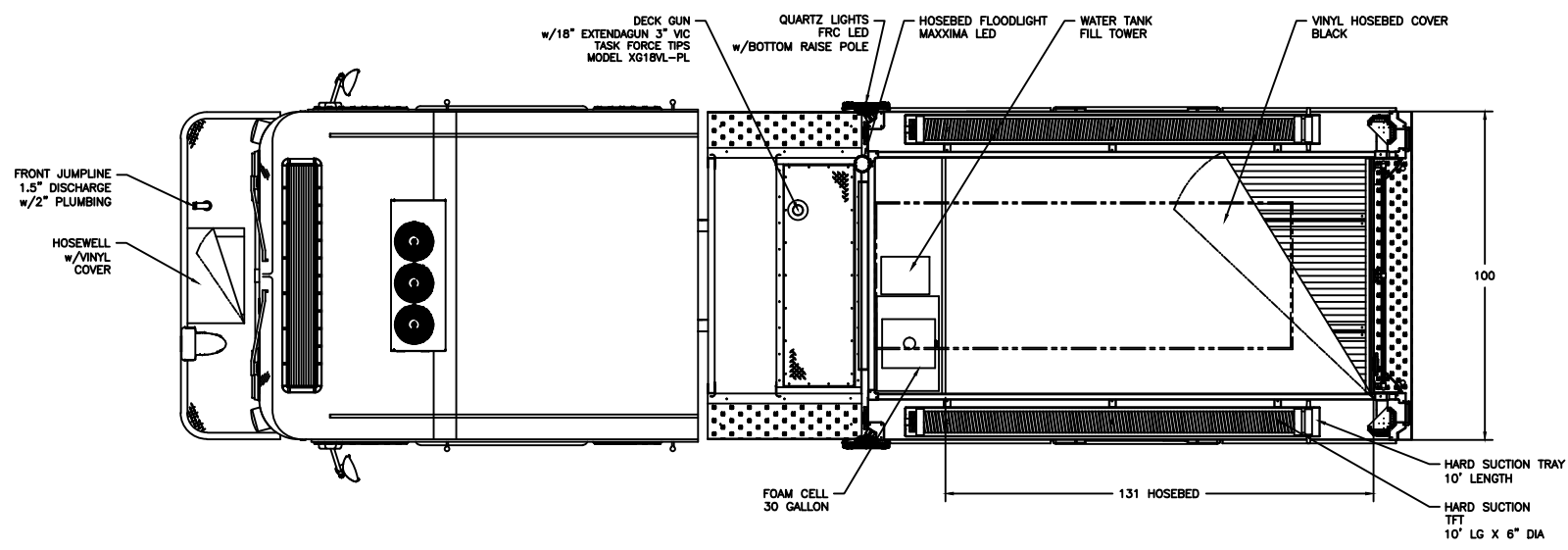

COMPARTMENTATION						
COMPT.	BEHIND DOOR		CLEAR OPENING		COMPT. VOLUME	
	WIDTH	HEIGHT	DEPTH	DOOR WIDTH	DOOR HEIGHT	
L1:	56"	63"	24"	47"	55"	49 FT ³
L2:	52"	33"	24"	49"	24"	23.8 FT ³
L3:	51"	63"	24"	47"	55"	44.6 FT ³
R1 LOWER:	56"	30"	24"	47"	55"	23.3 FT ³
R1 UPPER:	56"	33"	12"	47"	55"	12.8 FT ³
R2:	52"	33"	12"	49"	24"	11.9 FT ³
R3 LOWER:	51"	30"	24"	47"	55"	21.3 FT ³
R3 UPPER:	51"	33"	12"	47"	55"	11.7 FT ³
RR1:	48"	63"	22"	45"	46"	38.5 FT ³

A	JC	07 DEC '21	ORIGINAL RELEASE
LET	BY	DATE	REVISION
 1950 BYRON CENTER AVE. WYOMING, MI. 49519			
THIS PRINT IS PROVIDED ON A RESTRICTED BASIS AND IS NOT TO BE USED IN ANY WAY DETRIMENTAL TO THE INTERESTS OF HME, INC.			
NAME HME SF22			
DRAWN J. CROSBY	DATE 07 DEC '21	APPROVED N/A	DRAWING FILE 23908 - HME SF22.DWG
THIRD ANGLE PROJECTION	SIZE B	NUMBER 23908	SCALE NTS SHEET 1 OF 1

CREATED WITH AutoCAD®